

Leak Detection Sensors

- ▶ Compact Size
- ▶ Low Cost
- ▶ Reliable
- ▶ Hydrocarbon Detection

Warrick® Leak Detection Sensors are designed for single wall piping, sump alarms and other small areas. Combine with Warrick Monitoring Panels for complete leak detection systems.

LEVEL SWITCHES – SINGLE POINT

DLP-1 & DLP-2

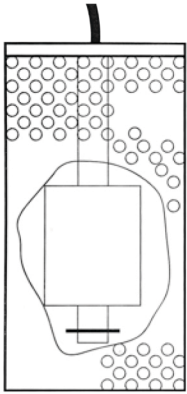

Designed to detect presence of liquid in sumps, attached access pipes, annular spaces, or locations requiring a small float-operated sensor. Two models to fit 1-1/2" and 2" standard piping.

DWP-25



Designed for use in the annular space of double wall fiberglass tanks to detect the presence of conductive liquid. When combined with Warrick DMS or TA alarm panel, DWP-25 sensors can detect the presence of water or other conductive liquids in normally dry annular spaces.

DFP-25



Designed for use in the annular space of double wall fiberglass tanks to detect hydrocarbon liquids. When hydrocarbons are present, a hydrocarbon wax pellet dissolves and closes a springloaded switch to signal a leak. This sensor is not reuseable after exposure to hydrocarbons.

SVP-2

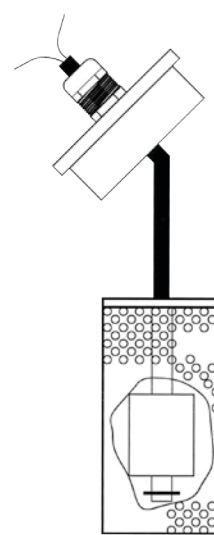

Designed to monitor hydrocarbon vapors in wells or sumps by absorbing the vapors and triggering a switch. Should not be used where vapors are continuously present. Fits in standard 2" pipe with cover.

DSP-2

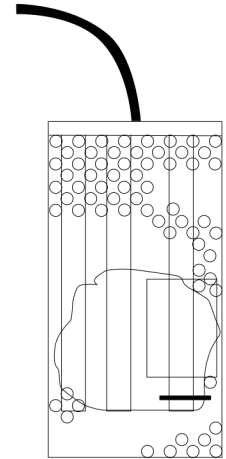

Utilizes conductivity probes and a reed switch based float switch to detect the presence of liquid and differentiate between hydrocarbons and water. When combined with Warrick DMS or TA two-channel alarm panel, the DSP-2 can discriminate between water and hydrocarbon liquids causing fault condition.

How to Order

Order by Part Number (same as Series Name for these products).

Series	Body Components	Number of Sensor Wires	Wire Length	O.D.	Part Number
DLP-1*	Buna-N float, Stainless Steel and plastic housing	2 (N.O. in resting position)	16 ft.	1.22"	DLP-1
DLP-2*				1.88"	DLP-2
DSP-2*					DSP-2
DWP-25	Stainless Steel probes in plastic housing	2	25 ft.	.625"	DWP-25
DFP-25	Spring-loaded switch, plastic housing, wax pellet	2	25 ft.	.625"	DFP-25
SVP-2	Chemical-resistant plastic and Stainless Steel housing	2	16 ft.	2"	SVP-2

* EPA Approved when used with Warrick TA or DMS panel. See pages E-27 and E-28 respectively.

Applications

- Above Ground Storage Tanks
- Underground Storage Tanks
- Sumps
- Dry Annular Spaces

LS-10 Series – Slim Profile for Interstitial Liquid Sensing

The Gems LS-10 liquid sensor accurately detects the presence of liquid in fiberglass double-wall tanks, containment sumps and double-wall pipes. Dry contact switching ensures dependability throughout its long service life. This reusable sensor easily fits small, interstitial spaces and senses liquid hydrocarbons or water. The unit is unaffected by hydrocarbon vapor, thereby reducing the risk of false alarms.

The LS-10 sensor's rounded design makes it easy to remove, clean and reinstall after an alarm condition is triggered, or for maintenance.

Dimensions

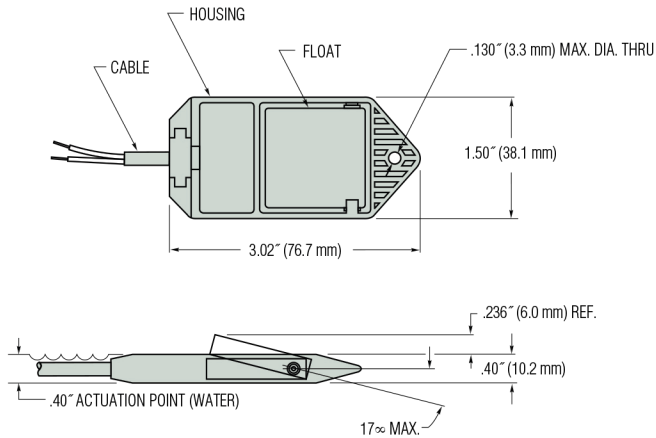

Specifications

Wetted Materials:

Housing: Valox®

Float: Foamed Polyethylene with Solid Polyethylene Pin

Tape: UHB Double-Sided 3M Tape

Cable: PVC

Pressure: Atmospheric

Operating Temperature: -40°F to +176°F (-40°C to +80°C)

Accuracy: ±1/8 inch

Switch Rating: 10W, 50-100 VDC Resistive Only, N.C. (opens on rising)

Cable: Two (2) Conductor PVC Jacketed 25 ft. Extended

Approvals: UL Recognized

How to Order – Select Part Number based on mounting option

Series Number	Mounting Option	Part Number
LS-10	25' PVC Jacketed Cable	156000 ⚡

Note: The LS-10 sensor is a non-voltage producing device and does not contain energy storing components. However, since primary use is in hazardous locations, an appropriate intrinsically safe interface device is required for its use.



Typical Applications

- ▶ Fiberglass Double-Wall Tanks
- ▶ Double Wall Pipes
- ▶ Containment Sumps
- ▶ Piping Sumps

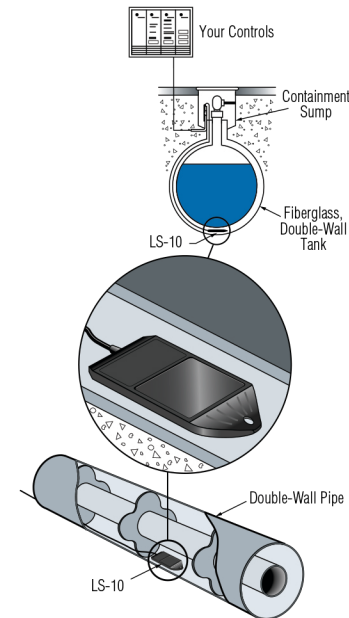

Typical Wiring Diagrams

Non-Isolated System—Single Zener Barrier

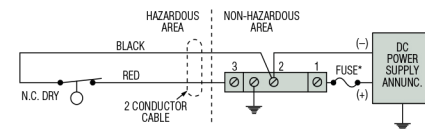

Isolated System - Dual Zener Barrier

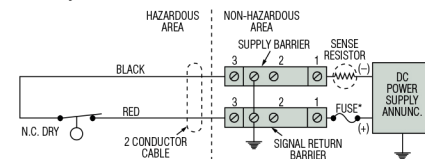

If two signal lines must be maintained above ground potential, an individual zener barrier is required per single line.

Single Safe-Pak® Relay

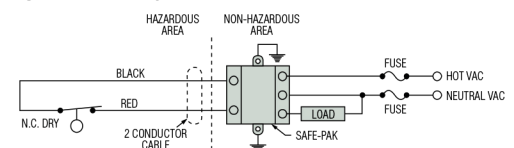

Safe-Pak® is an intrinsically safe, solid state relay

LEVEL SWITCHES – SINGLE POINT