



Next Day Shipping
On Many Configurations

D Series – High Flow

- ▶ MOPD: 900 PSI (62 Bar)
- ▶ C_v Range: 0.045 to 0.880 (K_v Range: 0.038 to 0.748)
- ▶ 10 Watts

For maximum flow in a miniature solenoid valve the D Series valves delivers a wide range of C_v (K_v) values and maximum operating pressures. The D Series is also available in multiple body materials, seal materials, coil constructions, voltages, and wattages. Proven to perform for millions of cycles without failure, the D valve—as with the entire valve series—is ideal for manifold configurations, sub-assemblies, and complete fluidic systems. The D Series is the largest in a progression—A Series, B Series, and C Series—of the highly flexible, modular design, (general purpose) valves.



Typical Applications

- Agriculture
- Defense
- Sterilization Equipment
- Industrial Automation

Dimensions

Threaded Port Body

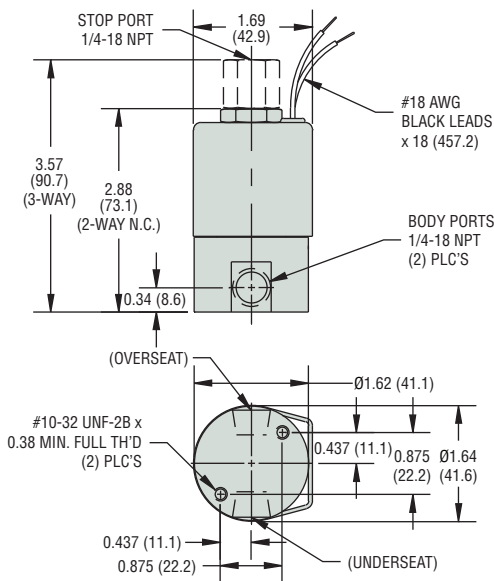

Manifold Mount Body

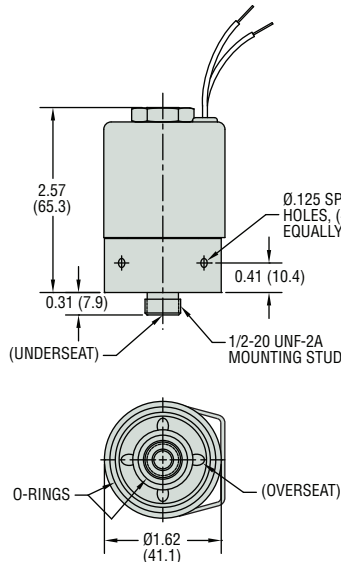

MANIFOLD MATING DIMENSIONS

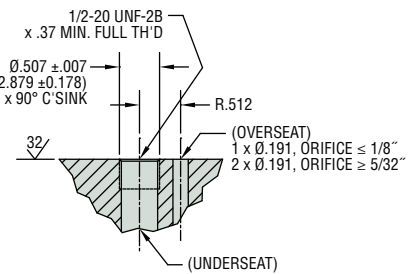

How To Order

Use the **Bold** characters from the choices listed on the following page to construct a product code.

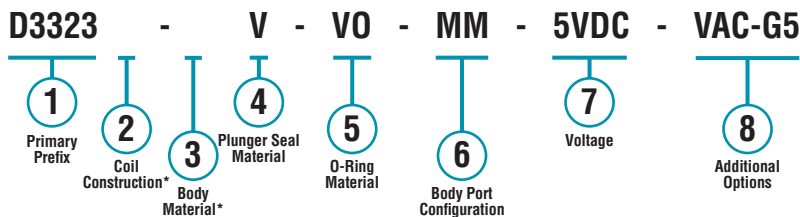

* Blank entry indicates a "Standard" selection (Tape-wrapped, Class-B, with 18" (46cm) lead-wires and 303 Stainless Steel, in this case).

Example:

D3323-V-VO-MM-5VDC-VAC-G5

3-Way Multi Purpose (with 1.26 Conduit Option) solenoid valve, with tape-wrapped, Class-B, with 18" (46cm) lead-wires, 303 stainless steel body, Viton® plunger seal, Viton® o-ring, manifold mount (1/2-20 UNF-2A mounting stud, max. orifice = 1/4" (35.6cm)), operating at 5 VDC, and includes vacuum application (0 to 29.5" Hg (0 to 1000mBar)) and one piece 316 stainless steel guide assembly options.

Alternate 1/2" Conduit Housing

Available on all body configurations

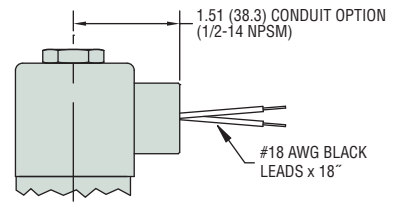











Take advantage of next day shipping by making your selections from those marked with the Lightning Bolt icon.

Part Prefix Table ①

	Orifice				MOPD		C _v		K _v		① Primary Prefix	
	Body		Stop		psig	bar	Body	Stop	Body	Stop	Grommet Housing	Conduit Housing
	inches	mm	inches	mm								
2-WAY N.C.	3/64	1.19	—	—	900	62	0.045	—	0.038	—	D2011 ⚡	D2021
	1/16	1.98	—	—	650	45	0.080	—	0.068	—	D2012 ⚡	D2022
	3/32	2.38	—	—	350	24	0.150	—	0.128	—	D2013 ⚡	D2023
	1/8	3.18	—	—	225	16	0.210	—	0.179	—	D2014 ⚡	D2024
	5/32	3.97	—	—	130	9.0	0.380	—	0.323	—	D2015 ⚡	D2025
	3/16	4.76	—	—	85	5.9	0.430	—	0.366	—	D2016 ⚡	D2026
	1/4	6.35	—	—	50	3.4	0.700	—	0.595	—	D2017 ⚡	D2027
	5/16	7.94	—	—	20	1.4	0.850	—	0.723	—	D2018 ⚡	D2028
3/8	9.53	—	—	10	0.7	0.880	—	0.748	—	D2019 ⚡	D2029	
2-WAY N.O.	—	—	3/64	1.19	900	62	—	0.045	—	0.038	D2211 ⚡	D2221
	—	—	1/16	1.59	550	38	—	0.080	—	0.068	D2212 ⚡	D2222
	—	—	5/64	1.98	300	21	—	0.110	—	0.094	D2213 ⚡	D2223
	—	—	3/32	2.38	175	12	—	0.150	—	0.128	D2214 ⚡	D2224
	—	—	1/8	3.18	110**	7.6	—	0.210	—	0.179	D2215 ⚡	D2225
	—	—	5/32	3.97	60**	4.1	—	0.380	—	0.323	D2216 ⚡	D2226
3-WAY N.C. Free Vent	1/16	1.59	1/16	1.59	175	12	0.080	0.080	0.068	0.068	D3011 ⚡	D3021
	5/64	1.98	5/64	1.98	150	10	0.110	0.110	0.094	0.094	D3012 ⚡	D3022
	3/32	2.38	3/32	2.38	125	8.6	0.150	0.150	0.128	0.128	D3013 ⚡	D3023
	1/8	3.18	1/8	3.18	85**	5.9	0.210	0.210	0.179	0.179	D3014 ⚡	D3024
	5/32	3.97	5/32	3.97	45**	3.1	0.380	0.380	0.323	0.323	D3015 ⚡	D3025
	3/16	4.76	5/32	3.97	30**	2.1	0.430	0.380	0.366	0.323	D3016 ⚡	D3026
	1/4	6.35	5/32	3.97	10**	0.7	0.700	0.380	0.595	0.323	D3017 ⚡	D3027
3-WAY N.C. Line Connection	1/16	1.59	1/16	1.59	175	12	0.080	0.080	0.068	0.068	D3111 ⚡	D3121
	5/64	1.98	5/64	1.98	150	10	0.110	0.110	0.094	0.094	D3112 ⚡	D3122
	3/32	2.38	3/32	2.38	125	8.6	0.150	0.150	0.128	0.128	D3113 ⚡	D3123
	1/8	3.18	1/8	3.18	85**	5.9	0.210	0.210	0.179	0.179	D3114 ⚡	D3124
	5/32	3.97	5/32	3.97	45**	3.1	0.380	0.380	0.323	0.323	D3115 ⚡	D3125
	3/16	4.76	5/32	3.97	30**	2.1	0.430	0.380	0.366	0.323	D3116 ⚡	D3126
	1/4	6.35	5/32	3.97	10**	0.7	0.700	0.380	0.595	0.323	D3117 ⚡	D3127
3-WAY N.O.	1/16	1.59	1/16	1.59	200	14	0.080	0.080	0.068	0.068	D3211 ⚡	D3221
	5/64	1.98	5/64	1.98	175	12	0.110	0.110	0.094	0.094	D3212 ⚡	D3222
	3/32	2.38	3/32	2.38	150	10	0.150	0.150	0.128	0.128	D3213 ⚡	D3223
	1/8	3.18	1/8	3.18	100**	6.9	0.210	0.210	0.179	0.179	D3214 ⚡	D3224
	5/32	3.97	5/32	3.97	50**	3.4	0.380	0.380	0.323	0.323	D3215 ⚡	D3225
	3/16	4.76	5/32	3.97	35**	2.4	0.430	0.380	0.366	0.323	D3216 ⚡	D3226
	1/4	6.35	5/32	3.97	15**	1.0	0.700	0.380	0.595	0.323	D3217 ⚡	D3227
3-WAY Multi Purpose	1/16	1.59	1/16	1.59	160	11	0.080	0.080	0.068	0.068	D3311 ⚡	D3321
	5/64	1.98	5/64	1.98	130	9.0	0.110	0.110	0.094	0.094	D3312 ⚡	D3322
	3/32	2.38	3/32	2.38	110	7.6	0.150	0.150	0.128	0.128	D3313 ⚡	D3323
	1/8	3.18	1/8	3.18	75**	5.2	0.210	0.210	0.179	0.179	D3314 ⚡	D3324
	5/32	3.97	5/32	3.97	40**	2.8	0.380	0.380	0.323	0.323	D3315 ⚡	D3325
	3/16	4.76	5/32	3.97	25**	1.7	0.430	0.380	0.366	0.323	D3316 ⚡	D3326
	1/4	6.35	5/32	3.97	10**	0.7	0.700	0.380	0.595	0.323	D3317 ⚡	D3327
3-WAY Directional Control	1/16	1.59	1/16	1.59	225	16	0.080	0.080	0.068	0.068	D3411 ⚡	D3421
	5/64	1.98	5/64	1.98	185	13	0.110	0.110	0.094	0.094	D3412 ⚡	D3422
	3/32	2.38	3/32	2.38	150	10.3	0.150	0.150	0.128	0.128	D3413 ⚡	D3423
	1/8	3.18	1/8	3.18	110**	7.6	0.210	0.210	0.179	0.179	D3414 ⚡	D3424
	5/32	3.97	5/32	3.97	60**	4.1	0.380	0.380	0.323	0.323	D3415 ⚡	D3425
	3/16	4.76	5/32	4.76	40**	2.8	0.430	0.380	0.366	0.323	D3416 ⚡	D3426
	1/4	6.35	5/32	3.97	20**	1.4	0.700	0.380	0.595	0.323	D3417 ⚡	D3427

** DC or rectified coil only

SOLENOID VALVES

2 Coil Construction**(blank)** = Tape-wrapped, Class B, with 18" (45.7cm) lead wires* **W**__ = Tape-wrapped coil, lead wires, non-standard length (specify in inches)**1** = Encapsulated coil, Class B, lead wires**3** = Encapsulated coil, Class H, lead wires**4** = Encapsulated coil, Class B, 1/4" (6.35mm) spade terminals**10** = Externally rectified coil, AC Voltages (lead-wires only) **11** = Tape-wrapped coil, Class H, lead wires**HC** = Encapsulated coil, Class B, EN175301-803 Style A, Industrial, 18mm, 2+1 poles**HC2** = Encapsulated coil, Class B, EN175301-803 Style C, Industrial, 9.4mm, 2+1 poles**3 Body Material****(blank)** = 303 Stainless Steel* **BB** = Brass**SB5** = 316 Stainless Steel**4 Plunger Seal Material****(blank)** = Nitrile* **E** = EPR **GV** = Gasoline Viton® – 2-way normally open and 3-way valves
max. orifice = 3/32" (2.38mm)**N** = Neoprene – 2-way normally closed valves only,
max. orifice = 1/4" (6.35mm) **NS** = Nitrile – NSF/FDA, max. orifice = 1/4" (6.35mm) **PF** = Perfluoroelastomer – max. orifice = 1/4" (6.35mm) **R** = Rulon® – 2-way normally closed valves only,
max. orifice = 1/4" (6.35mm)**T** = PTFE – max. orifice = 1/4" (6.35mm)**V** = Viton® **5 O-Ring Material****(blank)** = Nitrile* **EO** = EPR **NO** = Neoprene **NSO** = Nitrile (NSF/FDA, 2-way valves only) **PFO** = Perfluoroelastomer **TO** = PTFE**VO** = Viton® **6 Body Port Configuration****(blank)** = 1/4-18 NPT female thread* **LC** = 1/8-27 NPT female thread – max. orifice = 5/16" (7.94mm)**LD** = 3/8-18 NPT female thread**LT** = 1/8-28 BSPT female thread – max. orifice = 5/16" (7.94mm)**LU** = 1/4-19 BSPT female thread**MM** = Manifold mount – 1/2-20 UNF-2A mounting stud,
max. orifice = 1/4" (6.35mm)^{††}**OB** = Omit body (operator style)**BI** = Bottom over-seat port, female thread
– max. orifice = 1/4" (6.35mm)**BO** = Bottom under-seat port, female thread**7 Voltage[†] (see note below)****C203** = 12 VDC **C204** = 24 VDC **C301** = 120/50/60R (add Coil Option -10) **C303** = 240/50/60R (add Coil Option -10) ___ **VDC** = DC (specify voltage)___ **VAC** = AC (specify voltage; includes copper shading ring)**8 Additional Options****WM** = Mounting bracket on the coil housing**TP** = PTFE coated plunger**CP** = Chamfered plunger**S** = Silver shading ring**OC** = Cleaned for oxygen use**VAC** = Vacuum application – 0 to 29.5" Hg (0 to 1000mBar)**G5** = One piece 316 Stainless Steel guide assembly* Standard selection; will be used unless otherwise specified.
Standard selections are not referenced in final part number.[†] Can be AC rectified without shading ring. Use coil construction Code 10.
^{††} Teflon® o-ring not suitable for manifold mount.

Take advantage of next day shipping by making your selections from those marked with the Lightning Bolt icon.